



23351 Madero,
Mission Viejo, CA
92691. USA.
Tel: + 1 949 859 8800
Fax: + 1 949 859 9643
Email: sales@holtic.com
Web: www.holtic.com

HI-8428-R Eight Sensor Array with Ground/Open or Supply/Open and SPI interface. Evaluation Board

Quick Start Guide October, 2014

INTRODUCTION

This board demonstrates the features of the HI-8428-R eight input discrete sensor IC. The HI-8428-R is powered from 3.3V \pm 5% VLOGIC and 12 to 16.5V VDD supply voltages. The device is configured and sensor data read by the SPI serial bus, sensor input thresholds are fixed at Airbus specification levels. The EVM (Evaluation Module) contains a 16 bit, Freescale MC9S12XDT512 MCU, this is used to interface to a terminal emulator and control the HI-8428-R. The Holt CD, included with the evaluation kit, contains example source code, providing an easy path for the customer to develop their own control software. A Serial UART output from the MCU provides debug and data messages to be sent to a PC using any terminal emulation program such as Tera Term. The HI-8428-R Evaluation Board (shown in the picture below), two HI-8428-R devices are mounted on the board so the customer can evaluate SPI daisy chain operation.

A bank of LEDs monitors the outputs on either bank of eight sensors.

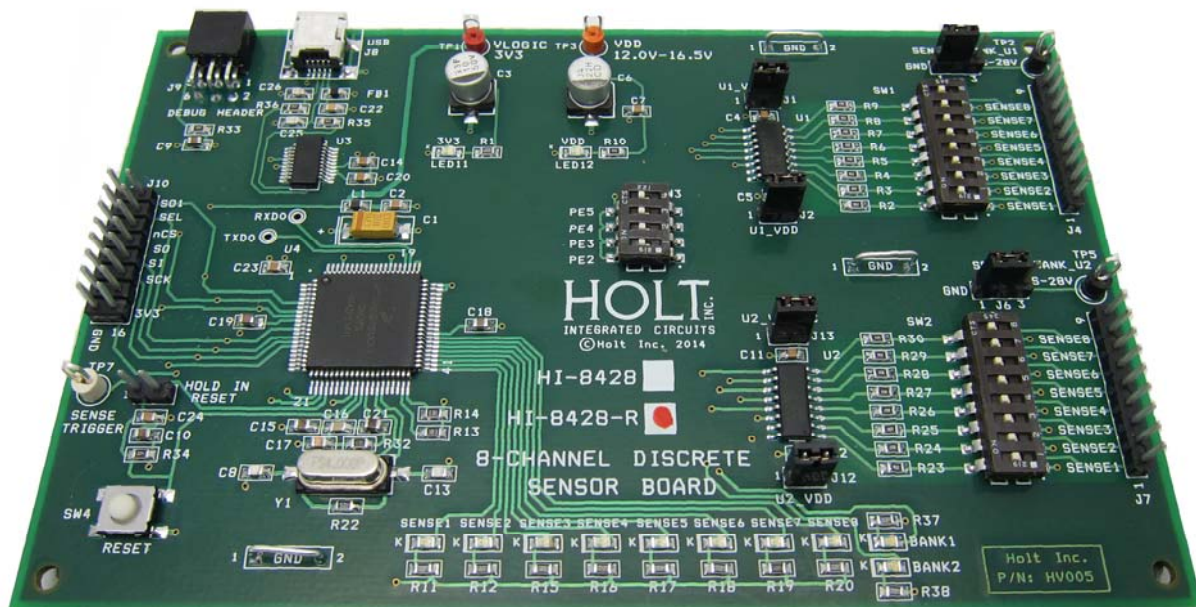

This guide summarizes how to set up and get running quickly. Additional support material is provided on CD-ROM.

KIT CONTENTS

- This User Guide.
- HI-8428-R Evaluation Board.

- CD with HI-8428-R Users Documentation.
- USB to Mini USB Serial Cable.

Demonstration Set-up

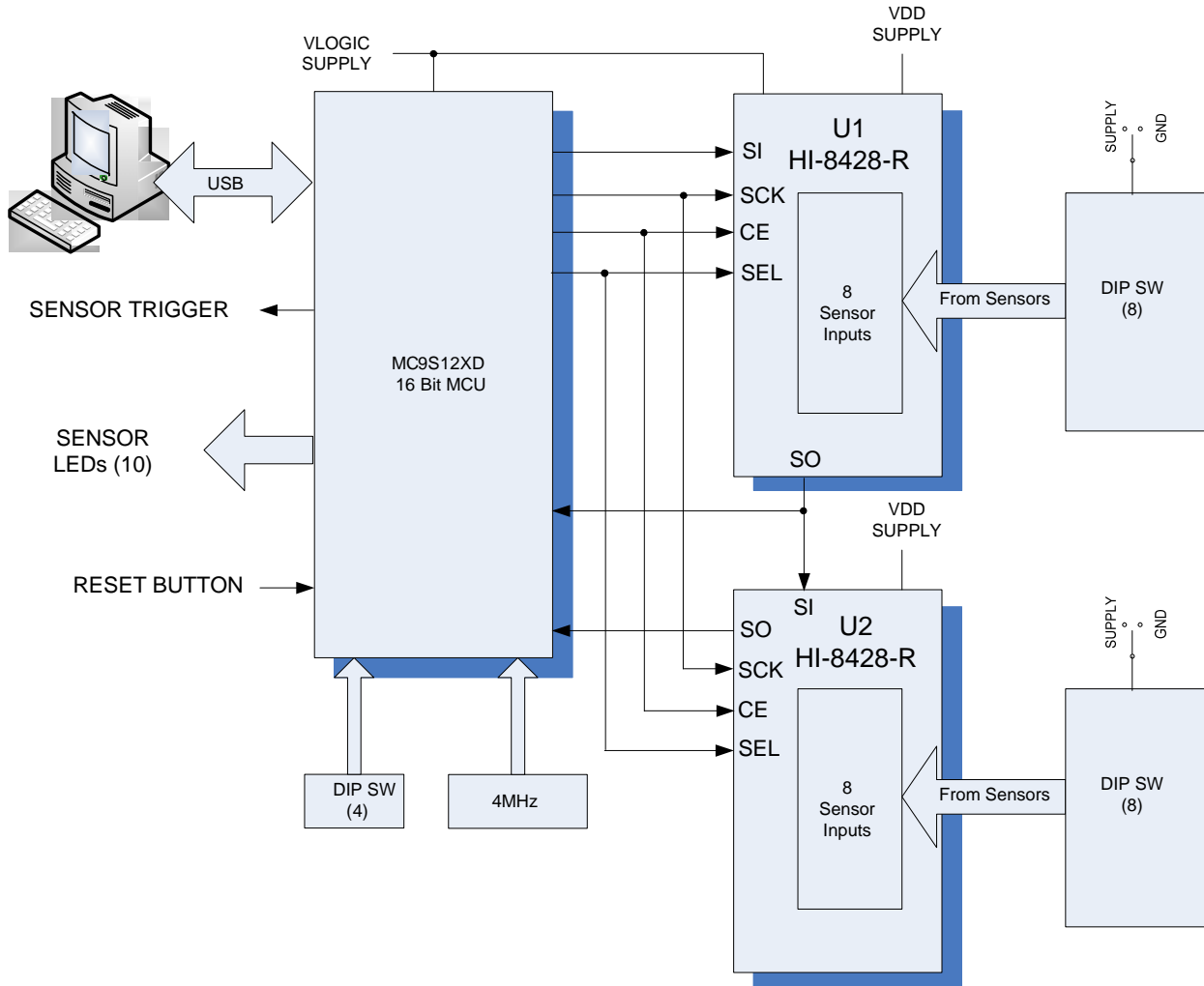

Default Jumper Settings

JUMPER	POSITION	DESCRIPTION
J1	ON	VLOGIC Link for supply current to U1 (disconnect to measure HI-8428-R VLOGIC supply current)
J2	ON	VDD Link for supply current to U1 (disconnect to measure HI-8428-R VDD supply current)
J13	ON	VLOGIC Link for supply current to U2 (disconnect to measure HI-8428-R VLOGIC supply current)
J12	ON	VDD Link for supply current to U2 (disconnect to measure HI-8428-R VDD supply current)
J3	3	U1 Sensor Switch 'On' Level Left = GND/Open Right = Supply/Open
J6	3	U2 Sensor Switch 'On' Level Left = GND/Open Right = Supply/Open n
J11	OFF	In ON position - holds the Freescale MCU in reset, use this when using an external SPI controller.

Default Switch Settings

SW1	POSITION	DESCRIPTION
SW1, 1-8	All ON	Sensor inputs for U1, Sensors 1-8, use in combination with J3
SW2, 1-8	All ON	Sensor inputs for U2, Sensors 1-8, use in combination with J6
SW3, PE2	ON	OFF = Boots up in GND/Open mode. LEDs monitor sensors
SW3, PE3	ON	OFF = Boots up in Supply/Open LEDs monitor sensors
SW3, PE4	ON	OFF = Boots up with LED counter running
SW3, PE5	ON	No Function
SW4, Reset	OFF	Press down to reset MCU and reboot software

Connector Functions

REF	NAME	DESCRIPTION
J4 pins 1-8	SENSE 1-8	Direct input to sensors 1 to 8 on U1
J4 pin 9	GND	Ground connection
J7 pins 1-8	SENSE 1-8	Direct input to sensors 1 to 8 on U2
J7 pin 9	GND	Ground connection
J8	USB	Connect to PC to send SPI commands from terminal emulator
J9	Debug Header	Used for downloading MCU firmware
J10	External SPI	SPI interface for U1/U2 (Insert jumper J11 when using this)
J11	Debug Header	Used for downloading MCU firmware

LED Functions

REF	NAME	DESCRIPTION
LED 1-8	SENSE 1-8	LED lights when sensor output is 'high', when using the software LED monitor feature.
LED 9	BANK1	LED lights when sensors from U1 are being monitored, when using the software LED monitor feature.
LED 10	BANK2	LED lights when sensors from U2 are being monitored, when using the software LED monitor feature.
LED 11	3V3	LED lights when VLOGIC power is present.
LED 12	VDD	LED lights when VDD power is present.

Initial Board Set up

1. Make sure the board jumpers and switch positions match the default settings listed earlier. Connect a +3.3V power supply to VLOGIC (RED) and 0V to GND terminals. Connect a +12V to +16.5V power supply to VDD (RED) and 0V to GND terminal. The VLOGIC and VDD terminals also supply other components, to measure only the HI-8428-R supply currents; remove the jumper for the device for (VDD or VLOGIC) and connect an ammeter across the two terminals; an accurate current measurement can now be made.
2. On power up the LED bank, SENSE[8:1] will light for 1 sec, the software revision is then displayed on the same LEDs, SENSE[8:5] being the most significant digit and SENSE[4:1] being the least significant digit.

Boot Up Options

1. Normally control of the HI-8428-R devices is through the on board MCU, and interfacing with a terminal emulator. However there are three boot up options selectable that do not need the terminal emulator, these are selected using SW3, see switch table on page 5.
2. The PE2 option sets GND/Open sensor mode for U1 and then monitors the sensor outputs on the Sense 1-8 LEDs, an illuminated LED means that sensor is Open (High).
3. The PE3 option sets Supply/Open sensor mode for U1 and then monitors the sensors outputs on the Sense 1-8 LEDs, an illuminated LED means that sensor is at Supply level (High).
4. The PE4 option starts the LED Count Test mode.
5. Options are changed by altering SW3 and hitting the Reset button.
6. When PE2, PE3, PE4 are all ON, then the normal software mode is selected, see next section.

Software Control

1. Connect the mini USB lead to your PC and then to the HI-8428-R board; your PC should automatically install the driver. If not the driver FT231 can be installed from the Holt CD. If you have problems installing the driver please refer to the FTDI website below:
2. <http://www.ftdichip.com/Documents/InstallGuides.htm>
3. For demo purposes, all control of the HI-8428-R is done through the 'Control Console'. This requires use of a terminal emulator for communication, such as HyperTerminal or Tera Term. Tera Term is used with Windows versions of Vista or later and is supplied on the Holt CD.

To install Tera Term:

Use the Tera Term installer, supplied on the Holt CD; run the teraterm-x.xx.exe installer program. Accept the license agreement stating redistribution is permitted provided that copyright notice is retained. The notice can be displayed from the Tera Term window by clicking **Help** then clicking **About Tera Term**.

- Accept the default install destination and click **Next**.
- At the Select Components screen, unselect all options except Additional Plugin = TTXResizeMenu and click **Next**.
- Select the installed language, then click **Next**.
- Accept the default Start Menu folder, then click **Next**.
- Select any desired shortcuts, then click **Next**.
- At the Ready to Install screen, click **Install**.

Run the installed Tera Term program. At the **New Connection** screen, select **(x)Serial** and choose the selected COM port, find the correct COM port using **Device Manager**.

4. Click **Setup** then **Serial Port** to open the serial port setup window.

Choose the COM port for the mini-USB connection and then select the following settings:
Baud Rate: 115200, Data: 8 bits, Parity: none, Stop: 1 bit, Flow Control: none

5. The evaluation software is pre-programmed into the MCU at the Holt Applications Support Center. Ensure all SW3 switches are 'ON', press the 'RESET MCU' button on the board, the software displays a message on the monitor, similar to the screenshot shown below.

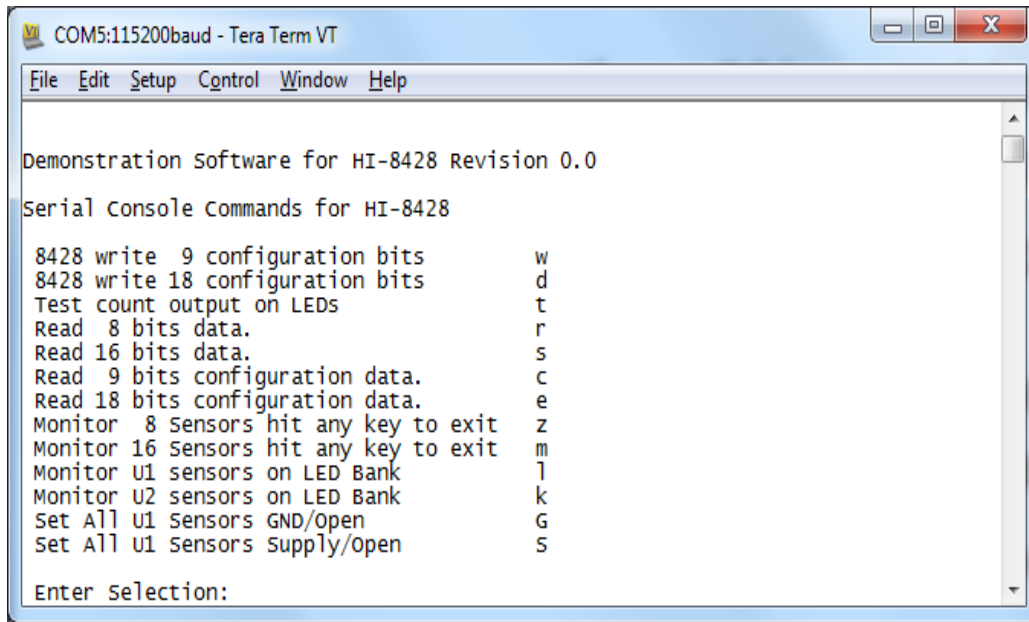

- Note: If under any circumstances, this software locks up, use the 'RESET' key to recover.
- Press key 't' to perform an LED test. The Sensor1-8 LEDs and screen should go through a binary count. To set a test data configuration; press key 'w' to write 9 configuration bits, enter 1 then 55, as shown in the screen below:

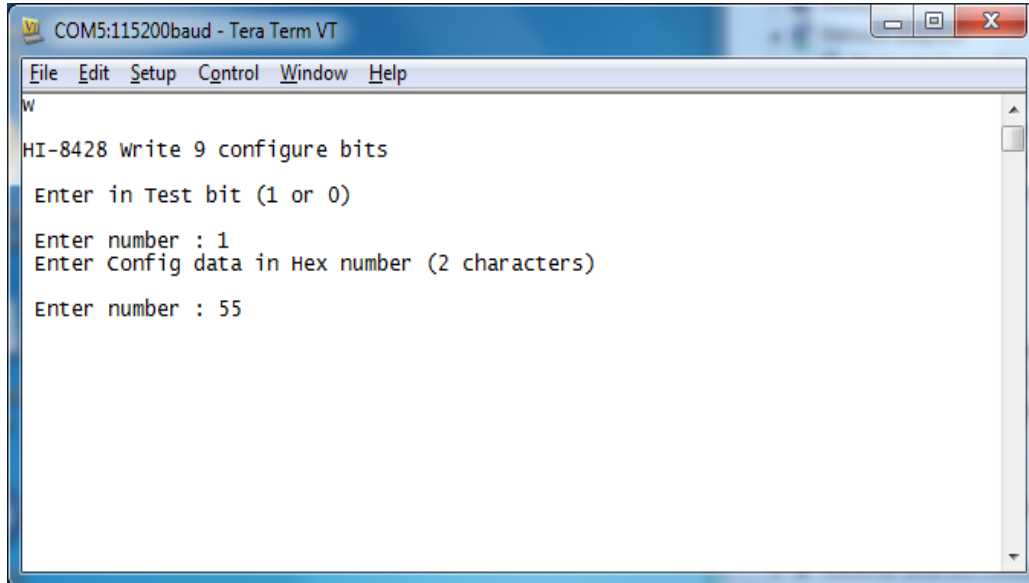

8. Press key 'c' to read configuration. The values you programmed (test bit 1, config = 0x55) should be displayed as shown in the screen below:

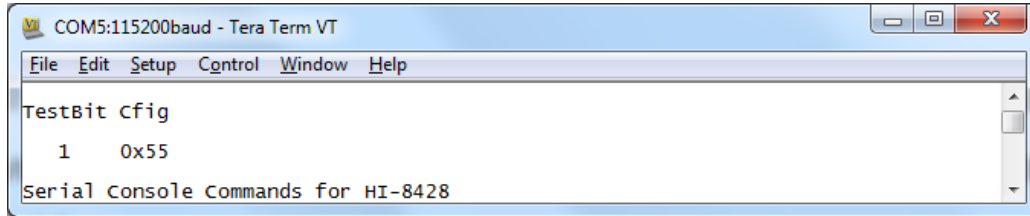

9. When the test bit is set to '1', test data can be placed into the data buffer through the SPI bus, this is a test feature which tests a large portion of the device, but not the comparator and threshold setting circuits. Press key 'r' to read data, only the test data should now be read, as shown below:

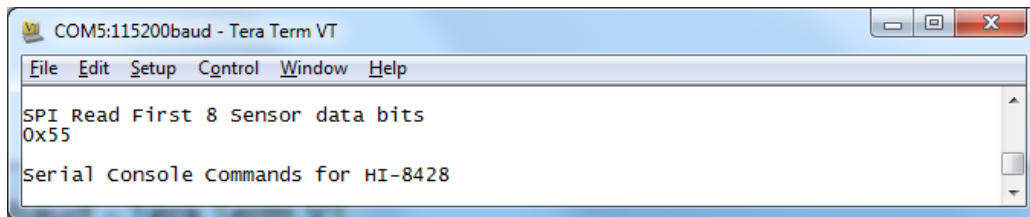

10. To configure all U1 sensors as GND/Open press key 'w' and set test bit to 0, then enter FF.

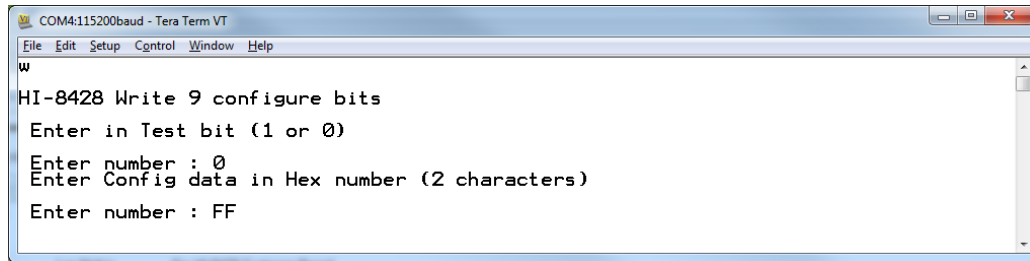

Press 'c' to read registers back to the screen and verify that the configuration reads;

0 0xFF

All 8 sensors are now set to detect the GND/Open states. The short cut keys 'G' and 'S' can also be used the set all sensors to GND/Open and Supply/Open respectively.

11. A quick test of the inputs can be made using DIP switch SW1, press key 'G' to set GND/Open mode, then key 'I' and 'A'. With the jumper SENSOR_BANK_U1 in position 1, set all switches to ON, this sets all inputs to GND level. Now open switch SW1/1, SENSE1 LED should light. Carry on opening the rest of the switches, each corresponding LED should now light.
12. The same test can be done for Supply/Open, set jumper SENSOR_BANK_U1 IN position 3, apply a voltage of 15V to the test point next to J3. Set all switches to OFF, this sets all inputs to Open level. Now close switch SW1/1, SENSE1 LED should light. Carry on closing the rest of the SW1 switches, each corresponding LED should now light.

Testing Sense Thresholds

1. In GND/Open mode, VGTHL is 4.5V min and VGTHH is 10.5V max. This can be tested by connecting a voltage source to the Sensor input pin on connectors J4 and J7. Make sure all SW1 DIP switches are in the OFF position. Connect a variable voltage source (initially set to 0V) to J4 pin 1, this tests Sensor 1 of U1. Use the short cut 'G' key to program all U1 sensors to GND/Open, press the 'I' key and then select '0' for sensor 1, the screen should scroll as shown below, this continually monitors the U1 sensor bank.

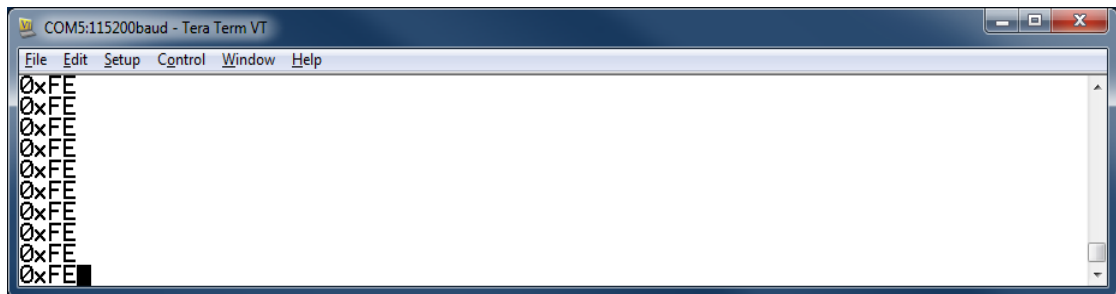

2. The screen above is monitoring U1 sensor 1, 0xFE means sensors 2 to 7 bits are at a '1', in GND/Open, and this means Opens are detected ($\geq 10.5V$). Because sensor 1 is held at 0V the last bit reads '0' or a Closed state ($\leq 4.5V$). Now increase the voltage source up to 9V, increase the voltage slowly, at 10.5V, LED1 on the board should be lit, the screen should now read 0xFF instead of 0xFE. Now decrease the voltage, LED1 should go off before 4.5V is reached.
3. Press any key then press key 'S' to set all sensors to Supply/Open mode. Press the 'I' key and then select '0' for sensor 1, the screen should scroll as before below but displaying 0x00, LED1-8 should be off. Again from 0V, slowly increase voltage until LED1 is lit, this voltage should be $\leq 12V$, now decrease the voltage, LED1 should go off before 6V is reached.

- An individual sensor can also be monitored from the hardware trigger output, by connecting to the Sense Trigger test point. This output can be used to measure high and low thresholds by inputting a ramp voltage to the sensor and then monitoring this on an oscilloscope, the test point is used to trigger the oscilloscope of the SPI mother board, when the sensor changes state; so does the level on sensor trigger.

Daisy Chained SPI Mode

- Two HI-8428-R devices are provided on the evaluation board, this allows the 'daisy chained' feature to be evaluated. U1 and U2 are linked together through the SPI connections; the SO pin of U1 is linked to the SI pin of U2. The software has commands that program and read both devices using this feature.
- Press key 'd' write 1, AA, 1, 55, press key 'e', the screen below should be seen.

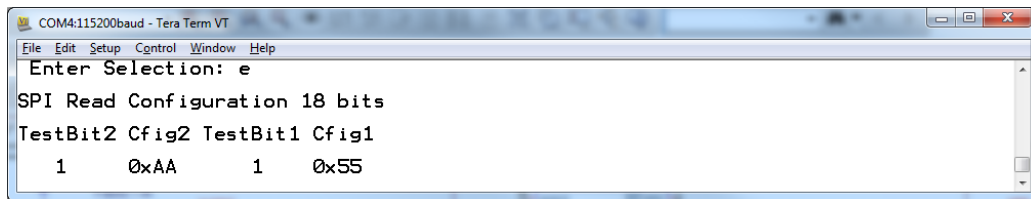

```

COM4:115200baud - Tera Term VT
File Edit Setup Control Window Help
Enter Selection: e
SPI Read Configuration 18 bits
TestBit2 Cfig2 TestBit1 Cfig1
1      0xAA      1      0x55

```

The configuration register of both devices has been set and read back through the daisy chain link.

- Configure the board with jumpers SENSE BANK_U1 and SENSE BANK_U2 is in the '1' position, press key 'd' and program 0, FF, 0, FF, all sensors are now programmed to GND/Open. Set all SW1, 2 switches to 'ON'.
- Press key 'm', the screen should scroll through, showing the sensor data 0x00 0x00 for each device, set SW1 to 0x55 and SW2 to 0xAA positions and observe the corresponding change on the screen. See example screen below.

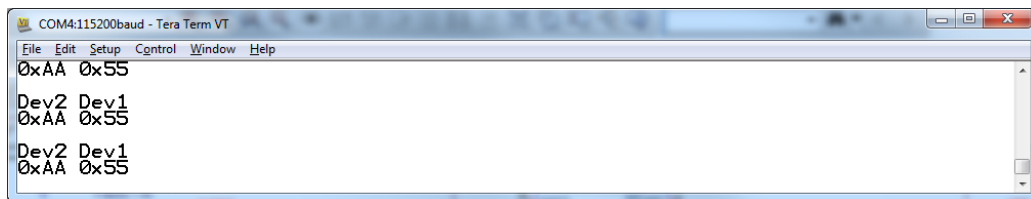

```

COM4:115200baud - Tera Term VT
File Edit Setup Control Window Help
0xAA 0x55
Dev2 Dev1
0xAA 0x55
Dev2 Dev1
0xAA 0x55

```

- The 'k' command can be used to read just the U2 sensors and monitor these on the SENSE1-8 LEDs, in the same way the 'l' command is used for U1. Press key 'k' and then 'A' the LEDs should read '10101010' and the BANK2 LED should be lit.

Connecting external sensors

To connect an external sensor, first make sure the corresponding DIP switches (SW1-2) are in the 'OPEN' state. The sensor wires can be connected to the board on the pin headers J4 for U1 and J7 for U2, see table below.

Pin Number	J4 U1	J7 U2
1	Sensor 1	Sensor 1
2	Sensor 2	Sensor 2
3	Sensor 3	Sensor 3
4	Sensor 4	Sensor 4
5	Sensor 5	Sensor 5
6	Sensor 6	Sensor 6
7	Sensor 7	Sensor 7
8	Sensor 8	Sensor 8
9	GND	GND

Connection pins for external sensors

Lightning Tests

The board comes fitted with a 3k Ω resistor on each sensor input; these resistors are not designed to survive a lightning test. If lightning tests are to be performed, please use a board designed for this and with the recommended resistor, contact Holt Support for guidance on this.

External SPI Operation

The HI-8428-R devices are normally controlled through the on-board MCU. If required, an external SPI master connected to J10 can be used. When using this method close jumper J11 to hold the MCU RESET pin low, this forces the MCU GPIOs into a high impedance state. For normal operation, keep this jumper open and use the RESET button to reset the MCU during testing.

Power should be connected between the VDD terminal and ground. The SPI controller should then be connected to J10, using the following pin connections:

SPI Connector (J10)

Pin Number	Label	Description
2	SO1	SPI Serial Output of U1
4	SEL	Select Input of U1 and U2
6	nCS	SPI Chip Select for U1 and U2
8	SO	SPI Serial Output from U2
10	SI	SPI Serial Data Input to U1
12	SCK	SPI Serial Clock Input
14	VDD	12 to 16.5V supply
16	3V3	3.3V supply
Odd Nos	Supply Ground (0V)	GND

J11 connection pins, for external SPI

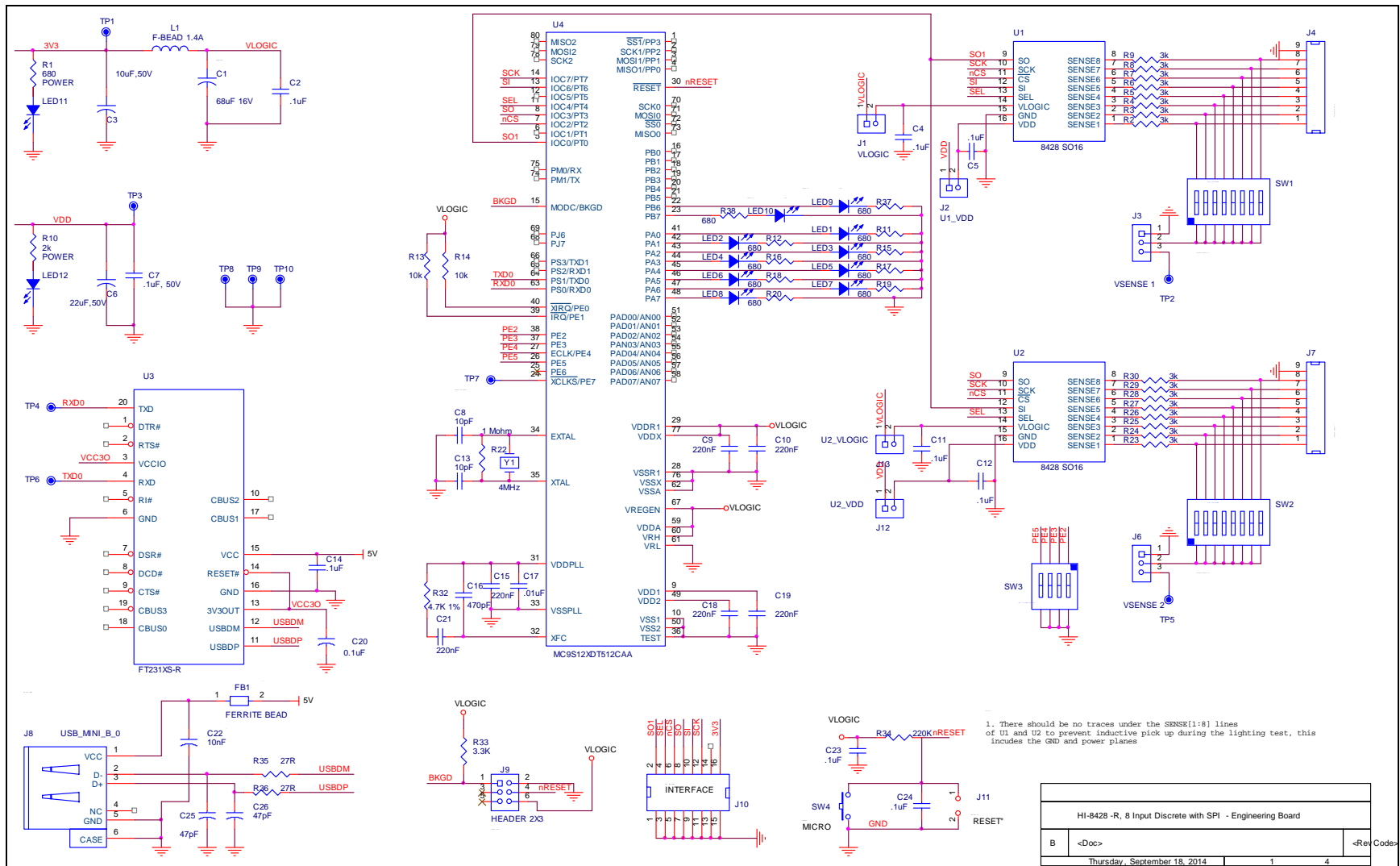

Bill of Materials		HI-8428-R Evaluation Board		Revised: 09/12/13
Qty	Description	Reference	DigiKey	Mfr P/N
1	PCB, Bare, Evaluation Board	N/A		Jet Tech # 36602
1	Capacitor 68uF,20%, 16V Tant SMD	C1	495-2254-1-ND	Kemet T491D686M016ZT
10	Capacitor, Cer 0.1uF 20% 50V Z5U 0805	C2,C4,C5,C7,C11,C12,C14,C20,C23,C24	399-1176-1-ND	Kemet C0805C104M5UACTU
1	CAP ALUM 10UF 50V 20% SMD	C3	493-9998-1-ND	Nichicon UWZ1H100MCL1GB
1	CAP ALUM 22UF 50V 20% SMD	C6	493-6180-1-ND	Nichicon UCD1H220MCL1GS
2	Capacitor, Cer 10pF 50V 5% NP0 0805	C8,C13	399-1108-1-ND	Kemet C0805C100J5GACTU
6	Capacitor, Cer .22uF 10% 50V X7R 0805	C9,C10,C15,C18,C19,C21	399-3491-1-ND	Kemet C0805C224K5RACTU
1	Capacitor, Cer 470pF 50V 5% X7R 0805	C16	399-1133-1-ND	Kemet C0805C471J5GACTU
2	Capacitor, Cer 0.01uF 20% 50V 7XR 0805	C17,C22	399-1160-1-ND	Kemet C0805C103M5RACTU
2	Capacitor, Cer 47pF 50V 5% NP0 0805	C25,C26	399-1117-1-ND	Kemet C0805C470J5GACTU
1	Ferrite 330 Ohm@100MHz 0805	FB1	490-5988-1-ND	Murata BLM21PG331SN1D
1	Ferrite 220 Ohm @100 MHz 0805	L1	490-1054-1-ND	Murata BLM21PG221SN1D
5	Conn Header .100 SGL STR 2Pos	Holt On Reset, U1-Logic, U1_VDD, U2_Logic, U2_VDD	S1012E-02-ND	Sullins PEC02SAAN
2	Conn Header .100 SGL STR 3Pos	J3,J6	S1012E-03-ND	Sullins PEC03SAAN
2	Conn Header .100 SGL STR 9Pos	J4,J7	S1012E-09-ND	Sullins PEC09SAAN
7	Conn Jumper Shorting .100" Tin	7 locations	S9341-ND	Sullins NPC02SXON-RC
1	Header, Male 0.1", Right Angle 2 x 3	Debug Header	S2312E-06-ND	Sullins PEC36DGAN
1	Conn Receptacle Mini USB2.0 5Pos	J8	H2959CT-ND	Hirose UX60-MB-5ST
1	Header, Male 2x8 0.1" Pitch, 0.230"/0.120" Tails	J10	S2012E-08-ND	Sullins PEC08DAAN

10	LED Green 0805	LED1- LED11	160-1179-1-ND	LiteOn LTST-C170GKT
1	LED Red 0805	LED12	160-1178-1-ND	LiteOn LTST-C170EKT
11	Res 680, 1/8W 5% 0805 SMD	R1,R11,R12,R15,R16,R17,R18,R19, R20,R37,R38	P680ACT-ND	Panasonic ERJ-6GEYJ681V
16	Res 3K, 1/8W 5% 0805 SMD	R2,R3,R4,R5,R6,R7,R8,R9,R23,R24,R25 ,R26, R27,R28,R29,R30	P3.0KACT-ND	Panasonic ERJ-6GEYJ302V
1	Res 2.0K, 1/8W 5% 0805 SMD	R10	P2.0KACT-ND	Panasonic ERJ-6GEYJ202V
2	Resistor, 10K 5% 1/8W 0805	R13,R14	P10KACT-ND	Panasonic ERJ-6GEYJ103V
1	Res 1M, 1/8W 5% 0805 SMD	R22	P1MACT-ND	Panasonic ERJ-6GEYJ105V
1	Res 4.7K, 1/8W 1% 0805 SMD	R32	P4.7KACT-ND	Panasonic ERJ-6GEYJ472V
1	Res 3.3K, 1/8W 5% 0805 SMD	R33	P3.3KACT-ND	Panasonic ERJ-6GEYJ332V
1	Resistor, 220K 5% 1/8W 0805	R34	P220KACT-ND	Panasonic ERJ-6GEYJ224V
2	Res 27, 1/8W 5% 0805 SMD	R35,R36	P27ACT-ND	Panasonic ERJ-6GEYJ270V
2	Switch Tape Seal 8 Pos SMD 50V	SW1,SW2	CT2198MST-ND	CTS 219-8MST
1	Switch Tape Seal 4 Pos SMD 50V	SW3	CT2194MST-ND	CTS 219-4MST
1	Switch Tactile SPST-NO 0.05A 32V	RESET	P12943SCT-ND	Panasonic EVQ-Q2K03W
1	Test Point, Red Insulator, 0.062"	3V3	5010K-ND	Keystone 5012
1	Test Point, Orange Insulator, 0.062"	VDD	5013K-ND	Keystone 5013
1	Test Point, White Insulator, 0.062"	Sense Trigger	5012K-ND	Keystone 5012
2	HI-8428-R 16-SOIC	U1,U2	HI-8428-R	HI-8428-R SOIC16
1	IC USB SERIAL FULL UART 20SSOP	U3	768-1129-1-ND	FTD FT231XS-R
1	IC, MC9S12XDT512CAA 80 QFP 16-Bit MCU, 512K Flash 0-70C	U4	MC9S12XDT512 CAA-ND	MC9S12XDT512CAA
1	Crystal 4.00MHz, SMD, 50ppm 20pF	Y1	631-1005-1-ND	FOXSDLF/040

REVISION HISTORY

Revision	Date	Description of Change
QSG-8428-R, Rev. New	9-12-14	New
QSG-8428-R, Rev. A	10-1-14	New board (SW1, SW2 location moved on schematic)